



GP-PWM-30-UL  
:: MAXIMUM  
POWER BOOST TECHNOLOGY™

# User Manual

## GP-PWM-30-UL

Dual Bank with Bluetooth® Wireless Technology



---

# Contents

<b>1.0</b>	<b>Installation Overview</b>	<b>4</b>
1.1	<i>Introduction</i>	4
1.2	<i>System Voltage and Current</i>	4
1.3	<i>Battery Type</i>	4
1.4	<i>Low Voltage Disconnect Function (USB Port, Inverter Remote Signal)</i>	4
1.5	<i>Bluetooth® Wireless Technology</i>	5
1.6	<i>Regulatory Information</i>	5
1.7	<i>Specifications</i>	5
<b>2.0</b>	<b>IMPORTANT SAFETY INSTRUCTIONS</b>	<b>7</b>
<b>3.0</b>	<b>Tools and Materials Needed</b>	<b>9</b>
<b>4.0</b>	<b>Choosing a Location</b>	<b>9</b>
<b>5.0</b>	<b>Choosing a Battery</b>	<b>9</b>
<b>6.0</b>	<b>Installation Instructions</b>	<b>10</b>
<b>7.0</b>	<b>Wiring Diagram</b>	<b>12</b>
7.1	<i>Charging Only One Battery</i>	13
7.2	<i>Charging Two Batteries</i>	13
<b>8.0</b>	<b>Operating Instructions</b>	<b>14</b>
8.1	<i>Power Up</i>	14
8.2	<i>Setting the Battery Type and Charging Profile</i>	15
8.3	<i>Battery Charging Profile Chart</i>	16
8.4	<i>Maximum Power Boost Technology™</i>	17
8.5	<i>Viewing the Controller Display Information</i>	17
8.6	<i>Resetting the Ampere Hours Charged</i>	19
8.7	<i>Errors</i>	20

---

<b>9.0</b>	<b>Display Symbols</b>	<b>21</b>
<b>10.0</b>	<b>Inverter Control (on/off)</b>	<b>23</b>
<b>11.0</b>	<b>USB Charging</b>	<b>24</b>
<b>12.0</b>	<b>Bluetooth® Wireless Technology</b>	<b>25</b>
12.1	<i>Pairing</i>	25
12.2	<i>App Settings</i>	27
12.3	<i>General Info</i>	27
<b>13.0</b>	<b>Frequently Asked Questions (FAQs)</b>	<b>28</b>
<b>14.0</b>	<b>Troubleshooting Problems</b>	<b>30</b>
14.1	<i>Problems with the Display</i>	30
14.2	<i>Problems with Voltage</i>	31
14.3	<i>Problems with Current</i>	31
<b>15.0</b>	<b>Limited Warranty</b>	<b>34</b>
15.1	<i>Repair and Return Information</i>	34
<b>16.0</b>	<b>Installation Template</b>	<b>34</b>

# 1.0 Installation Overview

## 1.1 Introduction

A Solar Controller (or Charge Controller / Regulator) is an essential component of your photovoltaic solar system. The Controller maintains the life of the battery by protecting it from overcharging. When your battery has reached a 100% state of charge, the Controller prevents overcharging by limiting the current flowing into the batteries from your solar array.

The GP-PWM-30-UL uses Pulse Width Modulation (PWM) technology and a unique four stage charging system that includes an optional equalize setting to charge and protect your battery bank. The GP-PWM-30-UL features an LCD digital display that shows the charge current of the solar array, system battery voltage and battery state of charge. The GP-PWM-30-UL also features Maximum Power Boost Technology™ for manual bulk and absorption charge at any stage of the charge cycle.

## 1.2 System Voltage and Current

GP-PWM-30-UL is intended for use at 12 VDC system voltage and is rated for a maximum continuous DC input current of 37.5A and input voltage of 35VDC.

Per National Electrical Code (NEC) article 690.7 and 690.8, PV module nameplate ratings must be multiplied by required values (typically 1.25 for both voltage and current) to obtain the maximum voltage and continuous current available from the module.

Applying NEC factors, the maximum allowable nameplate PV Panel rated  $I_{sc}$  is 30A ( $30A \times 1.25 = 37.5A$ ), and the maximum voltage,  $V_{oc}$  is 28VDC ( $28VDC \times 1.25 = 35VDC$ ).

The voltage and current ratings of all equipment connected to PV panels must be capable of accepting the voltage and current levels available from PV panels installed in the field.

## 1.3 Battery Type

The GP-PWM-30-UL is suitable for use with lead acid batteries (vented, GEL, or AGM type) as well as some lithium iron phosphate ( $LiFePO_4$ ) batteries that are supplied with a Battery Management System (BMS).

## 1.4 Low Voltage Disconnect Function (USB Port, Inverter Remote Signal)

To protect the battery against over-discharge this function automatically switches off the USB output port when Battery 1 voltage is lower than 11.0 VDC. If a

compatible inverter is connected and set to remote mode, the controller will also switch off the inverter. This will occur with a delay of 2 to 3 minutes.

As soon as Battery 1 reaches a voltage of 12.2 VDC (for LFP) or 12.8 VDC (for SEALED, AGM, or FLOODED) the USB output port is switched on again. If a compatible inverter is connected and in remote mode, it will also be switched on again.

## 1.5 Bluetooth® Wireless Technology

The latest versions of GP-PWM-30-UL have integrated Bluetooth® Low Energy wireless technology ready to be paired to your mobile device using the Go Power! Connect app available for download from the App Store and Play Store.

## 1.6 Regulatory Information



PHOTOVOLTAIC CHARGE  
 CONTROLLER FOR USE IN LAND  
 VEHICLES  
 NO. E500409

## 1.7 Specifications







Description	Value	
Model	GP-PWM-30-UL	Dimensions (H x W x D): 108 x 190 x 35 mm 4.25 x 7.48 x 1.38 in
Nominal System Voltage	12 VDC	
Charging Output Voltage Range Battery 1	9.0 – 14.9 VDC	Weight: 300g / 10.6 oz
Charging Output Voltage Range Battery 2	9.0 – 14.9 VDC	Maximum Wire Gauge: #4 AWG
Maximum Charge Current Battery 1	37.5A	Warranty: 5 years
Maximum Charge Current Battery 2	37.5A	<ul style="list-style-type: none"> <li>• PWM Charging</li> </ul>
Maximum DC Input Voltage	35.0 VDC	<ul style="list-style-type: none"> <li>• 3 Battery Charging profiles</li> </ul>
Range of DC Input Voltage	9.0 – 35.0 VDC	<ul style="list-style-type: none"> <li>• 4 Stage Charging</li> </ul>
Maximum DC Input Operating Current	37.5 A	<ul style="list-style-type: none"> <li>• Monthly Equalize option</li> </ul>
Maximum DC Short Circuit Current	37.5 A	<ul style="list-style-type: none"> <li>• Displays Charging Current, Battery Voltage and Battery State of Charge</li> </ul>
Max. Series Fuse or Circuit Breaker Solar/Battery 1/Battery 2	50 A	<ul style="list-style-type: none"> <li>• Reverse Polarity protected</li> </ul>
Operating Consumption (Display backlight on)	15mA	

Operating Consumption (Display backlight off)	6mA		<ul style="list-style-type: none"> <li>• Temperature Compensated</li> <li>• RoHS Compliant, environmentally safe</li> <li>• Accepts up to 500 watts of solar at 12 volts</li> <li>• Maximum Power Boost Technology</li> </ul>
Battery Types Supported	Vented and Sealed (GEL, AGM etc.) Lead Acid Lithium Iron Phosphate (LFP or LiFePO <sub>4</sub> )		
Bulk/Absorption Voltage (Sealed/Gel, AGM, Flooded)	14.1/14.4/14.4V (25°C / 77°F), 30min / Day or 2hr if battery voltage < 12.3V		
Absorption Voltage (LiFePO <sub>4</sub> )	14.4V 30min / day		
Float Voltage (Sealed/Gel, AGM, Flooded)	13.7V (25°C / 77°F)		
Float Voltage (LiFePO <sub>4</sub> )	14.0V		
Equalization Voltage (Flooded only)	14.9V (25°C / 77°F), 2h / 28 Days or if battery voltage < 12.1V		
Temperature Compensation (Sealed/Gel, AGM, Flooded only)	- 24mV/°C / 13mV/°F		
USB charger	5V, 800mA		
Low Voltage Disconnect (USB, Inverter off signal)	11.0 VDC after 2 to 3 minutes, Reconnects once battery reaches: 12.8V for Sealed/Gel, AGM, Flooded 12.2V for LiFePO <sub>4</sub>		
Operating Temperature Display Operating Temperature	- 40 to 60°C / - 40 to 140°F - 10 to 55°C / 14 to 131°F		
Charge Current De-Rating  (Based on internal temperature of the controller)	Internal Temp.	Max Charge Output Current	
	<80°C/176°F	37.5A	
	80°C/176°F	22.5A	
	81°C/177.8°F	15A	
	82°C/179.6°F	7.5A	
	>82°C/179.6°F	0A	
Humidity	99% N.C.		
Protection	Battery Reverse Polarity, Solar Array Reverse Polarity, Over Temperature, PV Short Circuit, Over Current		
Communication	Bluetooth® (Use with Go Power! Connect app)		

## 2.0 IMPORTANT SAFETY INSTRUCTIONS

### SAVE THESE INSTRUCTIONS







THIS MANUAL CONTAINS IMPORTANT INSTRUCTIONS FOR MODEL GP-PWM-30-UL THAT SHOULD BE FOLLOWED DURING INSTALLATION AND MAINTENANCE OF THE CHARGE CONTROLLER.

	<b>Disconnect all power sources</b>	Electricity can be very dangerous. Installation should be performed only by a licensed electrician or qualified personnel.
	<b>Battery and wiring safety</b>	Observe all safety precautions of the battery manufacturer when handling or working around batteries. When charging, batteries produce hydrogen gas, which is highly explosive.
	<b>Wiring connections</b>	Ensure all connections are tight and secure. Loose connections may generate sparks and heat. Be sure to check connections one week after installation to ensure they are still tight.
	<b>Work safely</b>	Wear protective eyewear and appropriate clothing during installation. Use extreme caution when working with electricity and when handling and working around batteries.
	<b>Observe correct polarity</b>	Reverse polarity of the Battery 1 terminals will cause the controller to give a warning tone. Reverse connection of Battery 2 terminals will not cause an alarm. However, the controller <u>will not</u> charge or display information for Battery 2 on the LCD. The controller will not function unless Battery 1 terminals are connected to a battery with proper polarity. Failure to correct this fault could damage the controller.
	<b>Do not exceed the GP-PWM-30-UL max current ratings</b>	The maximum current of the solar system is the sum of parallel-connected PV module-rated short circuit Currents (Isc) multiplied by 1.25. The resulting system current is not to exceed 37.5A. If your solar system exceeds this value, contact your dealer for a suitable controller alternative.
	<b>Do not exceed the GP-PWM-30-UL max voltage ratings</b>	The maximum voltage of the array is the sum of the PV module-rated open-circuit voltage of the series connected modules multiplied by 1.25 (or by a value from NEC 690.7 provided in Table 690.7 A). The resulting voltage is not to exceed 35V. If your solar system exceeds this value, contact your dealer for a suitable controller alternative.

# IMPORTANTES INSTRUCTIONS DE SECURITE

## CONSERVEZ CES INSTRUCTIONS

CE MANUAL CONTIENT DES INSTRUCTIONS IMPORTANTES POUR LE MODÈLE GP-PWM-30-UL QUI DOIVENT ÊTRE SUIVIES PENDANT L'INSTALLATION ET L'ENTRETIEN DU GP-PWM-30-UL.

	<b>Débranchez toutes les sources d'énergie</b>	L'électricité peut être très dangereuse. L'installation ne doit être effectuée que par un électricien agréé ou du personnel qualifié.
	<b>Sécurité de la batterie et du câblage</b>	Respectez toutes les consignes de sécurité du fabricant de la batterie lorsque vous manipulez des batteries ou que vous travaillez à proximité de celles-ci. Lors de leur chargement, les batteries produisent de l'hydrogène gazeux hautement explosif.
	<b>Branchements de câblage</b>	Assurez-vous que tous les branchements sont serrés et sûrs. Des branchements lâches peuvent produire des étincelles et de la chaleur. Vérifiez tous les branchements une semaine après l'installation pour vous assurer qu'ils sont toujours serrés.
	<b>Travaillez en toute sécurité</b>	Lors de l'installation, portez des lunettes de protection et des vêtements adaptés. Faites preuve d'une grande prudence lorsque vous travaillez avec du matériel électrique et lorsque vous manipulez des batteries ou que vous travaillez à proximité de celles-ci.
	<b>Respectez la polarité correcte</b>	Une polarité inversée des bornes de la batterie 1 provoquera un signal sonore du régulateur. Une polarité inversée de la batterie 2 ne provoquera pas d'alarme. Cependant, le régulateur ne chargera pas et <u>n'affichera pas</u> d'informations relatives à la batterie 2 sur l'écran CL. Le régulateur ne fonctionnera que si ses bornes batterie 1 sont connectées à une batterie avec la polarité appropriée. Si ce défaut n'est pas corrigé, le régulateur risque d'être endommagé.
	<b>Ne dépassez pas le courant nominal maximum du GP-PWM-30-UL</b>	Le courant maximum du système solaire est la somme des courants de court-circuit (Isc) des modules PV connectés en parallèle, multipliée par 1,25. Le courant du système qui en résulte ne doit pas excéder 37,5 A. Si votre système solaire dépasse cette valeur, veuillez contacter votre revendeur pour obtenir un régulateur plus approprié.





**Ne dépassez pas la tension nominale maximum du GP-PWM-30-UL**

La tension maximum des panneaux est la somme de la tension à vide du module PV des modules connectés en série, multipliée par 1,25 (ou par une valeur de l'article 690.7 du Code National Électrique fournie dans le tableau 690.7 A). La tension qui en résulte ne doit pas excéder 35 V. Si votre système solaire dépasse cette valeur, veuillez contacter votre revendeur pour obtenir un régulateur plus approprié.

### 3.0 Tools and Materials Needed

- Flathead Screwdriver (for wire terminals)
- Philips Screwdriver (for mounting screws)

#### NOTE

If the GP-PWM-30-UL Controller was purchased with a Go Power! RV Solar Power Kit, then UV resistant wire is included. For instructions regarding the Go Power! RV Solar Power Kit installation, please refer to the Installation Guide provided with the Kit.

### 4.0 Choosing a Location

The GP-PWM-30-UL is designed to be mounted flush against a wall, out of the way but easily visible.

The GP-PWM-30-UL should be:

- Mounted as close to battery bank 1 as possible
- Mounted on a vertical surface to optimize cooling of the unit
- Indoors, protected from the weather

In an RV, the most common controller location is above the refrigerator. The wire from the solar array most commonly enters the RV through the fridge vent on the roof or by using the Go Power! Cable Entry Plate (sold separately) that allows installers to run wires through any part of the roof. PV connections should connect directly to the controller. Positive and negative battery connections must connect directly from the controller to the batteries. Use of a positive or negative distribution bus is allowed between the controller and battery as long as it is properly sized, electrically safe and an adequate wire size is maintained.

### 5.0 Choosing a Battery



The GP-PWM-30-UL is suitable for use with lead acid batteries (vented, GEL, or AGM type) as well as some lithium iron phosphate (LiFePO<sub>4</sub>) batteries that are supplied with a Battery Management System (BMS). If using lithium ion, it must be lithium iron phosphate (LiFePO<sub>4</sub>) chemistry with a BMS. No other chemistries are compatible.

Lithium batteries typically have maximum allowed charge currents. These maximums typically decrease in cold temperatures. GP-PWM-30-UL does not limit current for these restrictions, and system design of the solar array must account for this.

Be sure to follow all battery manufacturer safety instructions.

## 6.0 Installation Instructions

1. **Prepare for mounting.** Use the template provided on **page 35** to mark the four mounting holes and the cutting line for flush mounting your controller.
2. **Complete the installation of the solar modules.** If this GP-PWM-30-UL was purchased as part of a Go Power! Solar Power Kit follow the Installation Guide provided. Otherwise, follow manufacturer's instructions for solar module mounting and wiring.

	<p><b>Do not exceed the GP-PWM-30-UL max current ratings</b></p>	<p>The maximum current of the solar system is the sum of parallel-connected PV module-rated short circuit Currents (Isc) multiplied by 1.25. The resulting system current is not to exceed 37.5A. If your solar system exceeds this value, contact your dealer for a suitable controller alternative.</p>
	<p><b>Do not exceed the GP-PWM-30-UL max voltage ratings</b></p>	<p>The maximum voltage of the array is the sum of the PV module-rated open-circuit voltage of the series connected modules multiplied by 1.25 (or by a value from NEC 690.7 provided in Table 690.7 A). The resulting voltage is not to exceed 35V. If your solar system exceeds this value, contact your dealer for a suitable controller alternative.</p>
	<p><b>Ne dépassez pas le courant nominal maximum du GP-PWM-30-UL</b></p>	<p>Le courant maximum du système solaire est la somme des courants de court-circuit (Isc) des modules PV connectés en parallèle, multipliée par 1,25. Le courant du système qui en résulte ne doit pas excéder 37,5 A. Si votre système solaire dépasse cette valeur, veuillez contacter votre revendeur pour obtenir un régulateur plus approprié.</p>
	<p><b>Ne dépassez pas la tension nominale maximum du GP-PWM-30-UL</b></p>	<p>La tension maximum des panneaux est la somme de la tension à vide du module PV des modules connectés en série, multipliée par 1,25 (ou par une valeur de l'article 690.7 du Code National Électrique fournie dans le tableau 690.7 A). La tension qui en résulte ne doit pas excéder 35 V. Si votre système solaire dépasse cette valeur, veuillez contacter votre revendeur pour obtenir un régulateur plus approprié.</p>

3. **Select wire type and gauge.** If this GP-PWM-30-UL was purchased as part of a Go Power! Solar Power Kit, appropriate wire type, gauge and length is provided. Please continue to Section 8, “Operating Instructions.” If the GP-PWM-30-UL was purchased separately, follow the instructions included here.

Wire type is recommended to be a stranded copper UV resistant wire. Wire fatigue and the likelihood of a loose connection are greatly reduced in stranded wire compared to solid wire. Wire gauge should be able to sustain rated current as well as minimize voltage drop.

### Wire Strip Gauge

You will find a strip gauge diagram on the back of the GP-PWM-30-UL, which helps you to strip your wires to the correct length. Insert wire into the concave slot of the strip gauge until it meets the back of the Strip Gauge slot. Mark the length of wire from the back of the Strip Gauge slot to the edge of the controller with a pen or your finger and strip all wires to be connected to the controller to this length.

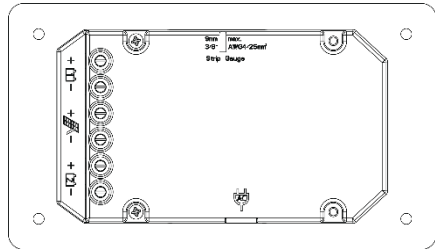

### Suggested Minimum Wire Gauge

(Cable length 25 ft. max. from solar array to battery bank)

Wire Type	Wire size min (AWG)	Wire size Max (AWG)
Copper Only, 90°C	AWG 10	AWG 4

**IMPORTANT:** Identify the polarity (positive and negative) on the cable used for the battery and solar module. Use colored wires or mark the wire ends with tags. Although the GP-PWM-30-UL is protected, a reverse polarity contact may damage the unit.

**Wiring the GP-PWM-30-UL.** Wire the GP-PWM-30-UL according to the wiring schematic in **Section 7**. Run wires from the solar array and the batteries to the location of the GP-PWM-30-UL. Keep the solar array covered with an opaque material until all wiring is completed.

**IMPORTANT:** All wiring must be in accordance to National Electrical Code, ANSI/NFPA 70.

4. **Connect** the battery wiring to the controller first and then connect the battery wiring to the battery.
5. **Torque** all terminal screws per the following:

Stranded Copper 90°C Wire	
Wire Size AWG	Rated Torque (in-lbs)
10	20
8	25
6	35
4	35

With battery power attached, the controller should power up and display information. Connect the solar wiring to the controller and remove the opaque material from the solar array. The negative solar array and battery wiring must be connected directly to the controller for proper operation. Do not connect the negative solar array or negative battery controller wiring to the chassis of the vehicle.

6. **Mounting the GP-PWM-30-UL.** Mount the GP-PWM-30-UL to the wall using the included four mounting screws.

**IMPORTANT:** You must set the battery type on the GP-PWM-30-UL before you begin to use the controller. The default battery setting is for AGM batteries.

Congratulations, your GP-PWM-30-UL should now be operational. If the battery power is low and the solar array is producing power, your battery should begin to charge.

7. **Re-torque:** After 30 days of operation, re-torque all terminal screws to ensure the wires are properly secured to the controller



**WARNING:** This unit is not provided with a GFDI device. This charge controller must be used with an external GFDI device as required by Article 690 of the National Electric Code for the installation location.



**AVERTISSEMENT :** Cet appareil n'est pas équipé d'un détecteur de défaut de terre. Ce régulateur de charge doit être utilisé avec un détecteur de défaut de terre comme l'exige l'article 690 du Code National Électrique pour l'emplacement de l'installation.

## 7.0 Wiring Diagram

The GP-PWM-30-UL Maximum 37.5A rating is based on a 30-amp total maximum short circuit current rating (Isc) from the solar modules nameplate ratings. The National Electric Code specifies the PV equipment/system rating to be 125% of the maximum Isc from the PV module ratings (1.25 times 30 = 37.5A). E.G. Three modules in parallel with an Isc of 7 amps each equal a total Isc input of 21 amps. When selecting PV modules for use with the GP-PWM-30-UL do not exceed a total nameplate Isc current of 30A. Solar modules list the Isc amps on their nameplate label.

## 7.1 Charging Only One Battery

Use the following wiring diagram if you are using the GP-PWM-30-UL to charge only one battery. Connect your battery to the battery 1 terminals on the solar controller.

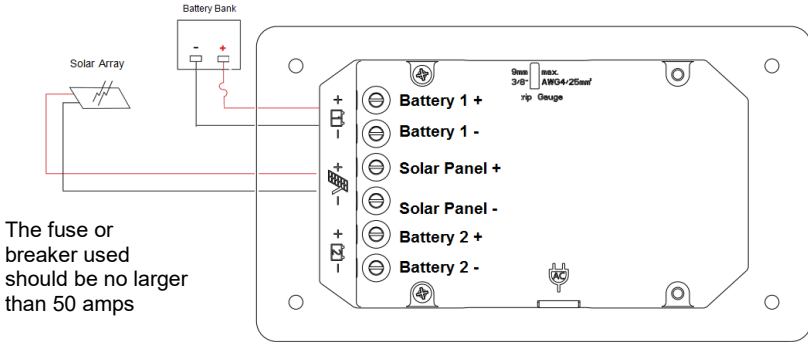

### NOTE

The controller will not work unless there is a battery connected to the Battery 1 terminals.



**WARNING:** When the photovoltaic (solar) array is exposed to light, it supplies a dc voltage to this equipment.



**AVERTISSEMENT:** Lorsque le panneau photovoltaïque (solaire) est exposé à la lumière, il fournit une tension cc à cet équipement.

## 7.2 Charging Two Batteries

Use the following wiring diagram if you are using the GP-PWM-30-UL to charge two separate battery banks. Connect battery bank 1 to the battery 1 terminals and battery bank 2 to the battery 2 terminals on the back of the solar controller.

**IMPORTANT:** Ensure your primary/permanent battery (house bank) is connected to the battery 1 terminals. Connect your secondary battery to battery 2 terminals only. Your permanent battery (battery 1) will receive the full current first. Once battery 1 is fully charged, current will be available to charge battery 2.

### NOTE

The controller will not work unless there is a battery connected to the battery 1 terminals.

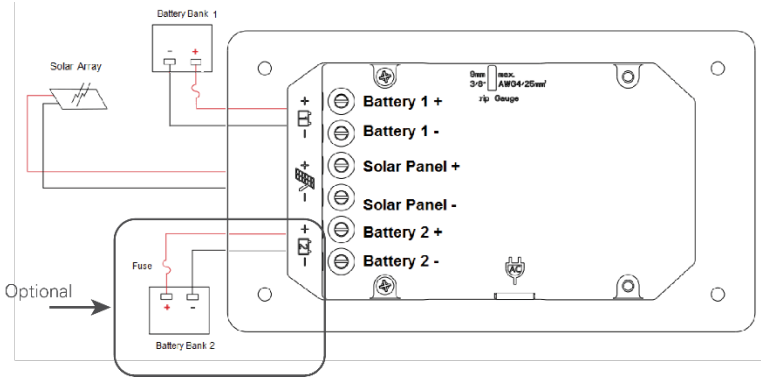

The fuses or breakers used should be no larger than 50 amps.



**WARNING:** When the photovoltaic (solar) array is exposed to light, it supplies a dc voltage to this equipment



**AVERTISSEMENT :** Lorsque le panneau photovoltaïque (solaire) est exposé à la lumière, il fournit une tension cc à cet équipement.

## 8.0 Operating Instructions

### 8.1 Power Up

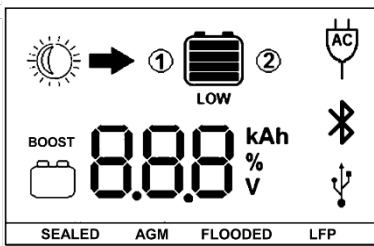

When the GP-PWM-30-UL is connected to the battery, the controller will go into Power Up mode.

**Icons Displayed:** All segments of the numerical display; Backlight blinks

Depending on the battery voltage when the GP-PWM-30-UL Power Up occurs, the controller may do a Boost Charge or quickly go into Float Charge. The Charging Profile selected will commence the following day after a Power Up (refer to the Charging Profile Chart on page 17-18 for more details).

## 8.2 Setting the Battery Type and Charging Profile

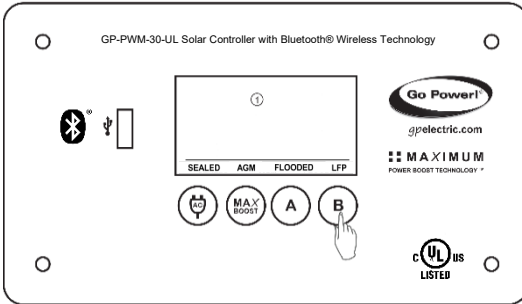

### Setting Battery 1

To set the battery type for battery bank 1, hold the **B Button** for 3 seconds. When the display shows a blinking number 1, release the **B Button**.

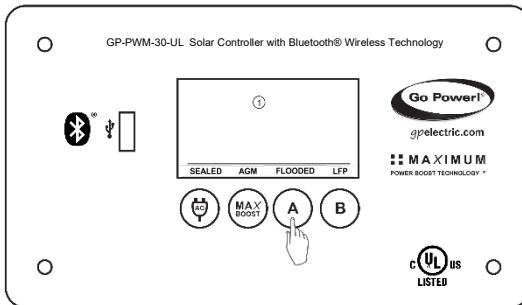

Next, select the charging profile of battery bank 1 by pressing the **B Button** to toggle through the profile options: Sealed/Gel, AGM, Flooded, or LFP.

To confirm the battery profile, press and hold the **A Button** for 3 seconds.

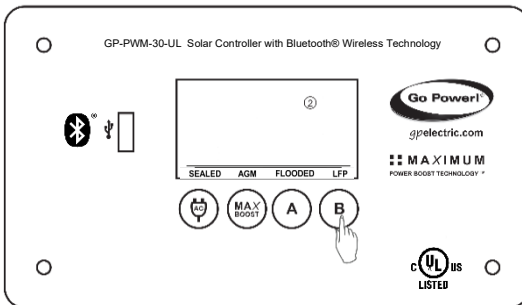

### Setting Battery 2

If you have a second battery bank connected, the controller will immediately prompt you to set the battery type for Battery 2 with a blinking number 2.

#### NOTE

If there is not a second battery bank connected to the controller, or if the second battery bank is connected with reverse polarity, the controller will not prompt you to select battery type for Battery 2, and no status information will be displayed on the LCD screen.

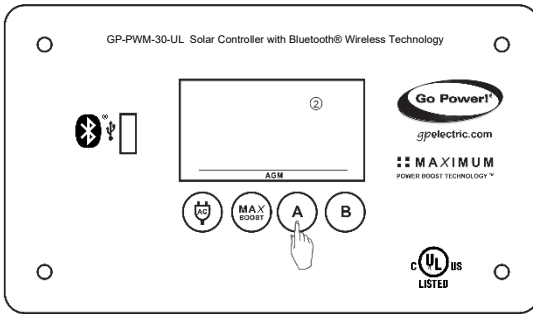

To select the charging profile of battery bank 2, press the **B Button** to toggle through the profile options: Sealed/Gel, AGM, Flooded, or LFP.

To confirm the battery profile, press and hold the **A Button** for 3 seconds.

**Non-volatile memory:** Any settings made on the GP-PWM-30-UL will be saved even when the power has been disconnected from the controller.

### 8.3 Battery Charging Profile Chart

Battery Type	SEALED	AGM	FLOODED	LFP
<b>Float Charge</b> at 25°C:	13.7 VDC			N/A
<b>Bulk/Absorption Charge</b> at 25°C: <i>Set to 30 minutes every morning. Applied for 2 hours if the battery voltage drops below 12.3 volts.</i>	14.1 VDC	14.4 VDC	14.4 VDC	N/A
<b>Equalization Charge</b> at 25°C: <i>Applied for 2 hours every 28 days and if the battery voltage drops below 12.1 volts.</i>	N/A	N/A	14.9 VDC	N/A
<b>Absorption Charge voltage for LiFePO<sub>4</sub>:</b> <i>Set to 30 minutes every morning.</i>	N/A			14.4 VDC
<b>Float Charge voltage for LiFePO<sub>4</sub>:</b>	N/A			14.0 VDC
<b>Temperature Compensation:</b>	-24mV/K			None
If a charging cycle is unable to complete in a single day, it will continue the following day. The terms SEALED/GEL, AGM, FLOODED, and LFP are generic battery designations. Choose the charging profile that works best with your battery manufacturer's recommendations.				

**Auto Equalize:** The GP-PWM-30-UL has an automatic equalize feature that will charge and recondition your batteries once a month at a higher voltage to ensure that any excess sulfation is removed.

**NOTE**

This feature is only available when Flooded batteries are selected.



## 8.4 Maximum Power Boost Technology™

Maximum Power Boost Technology™ (MPBT) allows you to override the normal charging algorithm of the solar controller. MPBT is designed to be used before the end of the day, if you know you will require many loads through the night. This feature can also be used when you have just installed the solar controller, to put batteries on a boost charge up to 14.4 VDC (Flooded, AGM and LFP) (14.1 VDC for Sealed/Gel) right away.

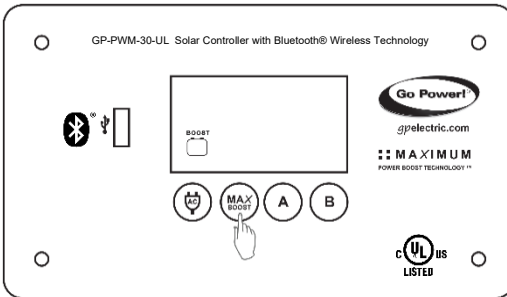

To activate, hold the **MAX BOOST Button** for 3 seconds. As long as there is full sunlight present, your battery voltage will be boosted (to 14.4 VDC for Flooded, AGM and LFP; and 14.1 VDC for SEALED/GEL) for 30 minutes regardless of the battery's state of charge.

**Icons Displayed:** BOOST; Battery Symbol

In older controllers, the BOOST text icon will remain on until the controller can maintain a Boost charge voltage for 30 cumulative minutes. In newer controllers, the BOOST text icon will only appear while the controller is maintaining a Boost charge voltage.

**IMPORTANT:** Do not use the Maximum Power Boost function more than twice a day as it could damage your lead acid batteries due to gassing. Sustained high voltages decrease lithium battery lifespan.

### NOTE

If sunlight is insufficient or not available, completing Max Power Boost may take much longer than 30 minutes from the time of the button press. Max Power Boost and the BOOST icon cannot be turned off by pressing the Max BOOST button.

## 8.5 Viewing the Controller Display Information

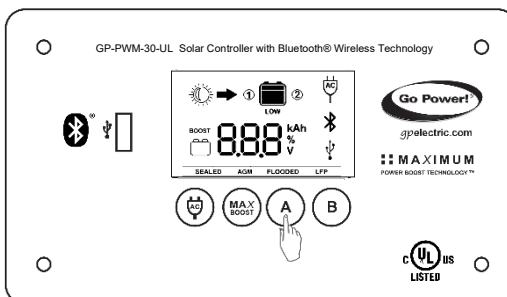

GP-PWM-30-UL has two modes to watch the display information, manual and auto scroll.

You can change between the two modes by holding down the **A Button** for 3 seconds.

## Mode 1: Manually Scroll Through Display Information

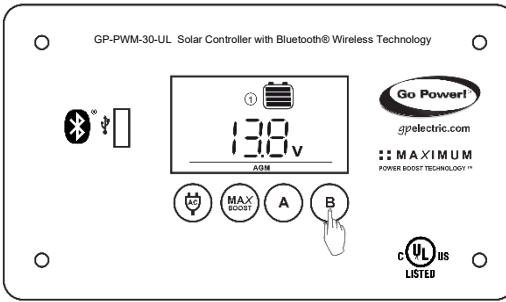

### Battery 1 Status Values

To toggle between Battery Voltage, Charging Current and Battery State of Charge (SOC) for Battery 1 and 2, press the **B Button**.

Push the **B Button** to show the voltage for Battery 1.

**Icons Displayed:** Battery SOC, Volt Symbol (V), Symbol 1

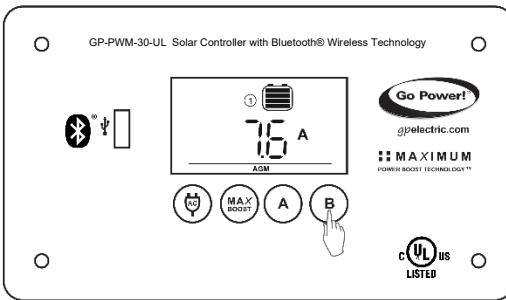

Push the **B Button** to show the PV charging current for battery 1. The GP-PWM-30-UL will begin to limit the current as Battery 1 reaches a full charge. The current that is not used for Battery 1, is used to charge Battery 2.

**Icons Displayed:** Arrow, Ampere Symbol (A), Battery SOC, Symbol 1

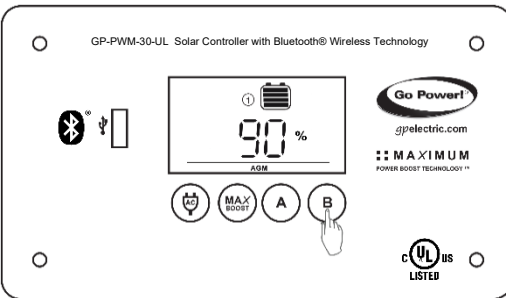

The battery state of charge is shown as a percentage.

**Icons Displayed:** Battery SOC, Percent Symbol (%), Symbol 1

A value of 100% will only be displayed after a Boost or Equalize charge completes.

### Battery 2 Status Values

Push the **B Button** to show the battery 2 voltage.

**Icons Displayed:** Battery SOC, Volt Symbol (V), Symbol 2

This will only be displayed if there are two battery banks connected and battery bank 2 is connected with correct polarity.

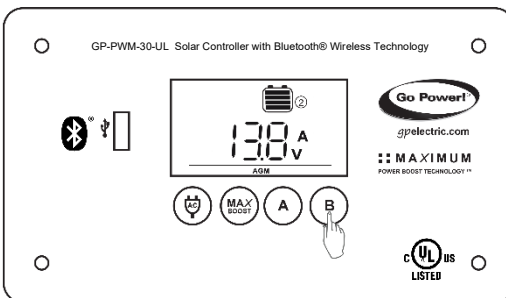

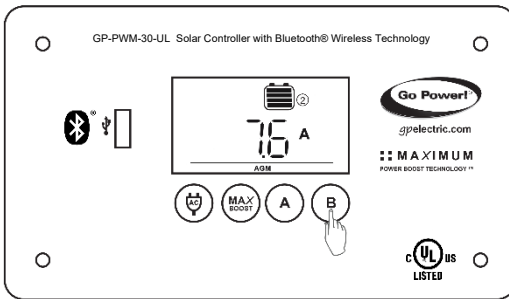

Push the **B Button** to show the PV charging current for battery 2. The GP-PWM-30-UL will begin to limit the current as the battery 2 reaches a full charge.

**Icons Displayed:** Arrow, Ampere Symbol, Battery SOC, Symbol 2

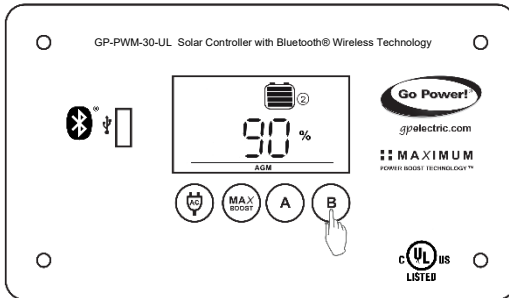

The battery state of charge is shown as a percentage.

**Icons Displayed:** Battery SOC, Percent Symbol (%), Symbol 2

## Mode 2: Automatically Change Display Information

You can select the auto mode by holding down the **A Button** for 3 seconds. The display shows the same information as in Mode 1 but changes the display automatically every 8 seconds between following information:

**Battery 1:** Voltage; PV Charging Current; Battery State of Charge (SOC)

**Battery 2:** Voltage; PV Charging Current; Battery State of Charge (SOC)

If Battery 2 is not connected, the Controller changes only the information for Battery 1.

## 8.6 Resetting the Ampere Hours Charged

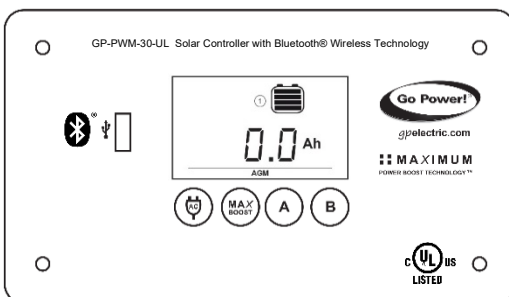

To reset the count of ampere hours charged, use the Go Power! Connect app (Bluetooth® enabled version only).

## 8.7 Errors

### Over Voltage

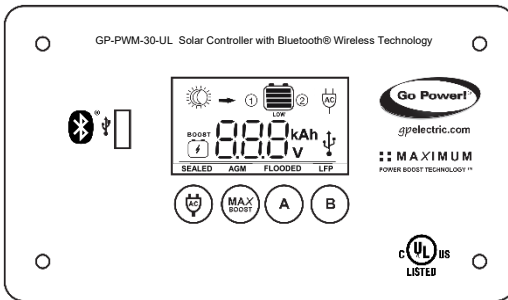

If the GP-PWM-30-UL experiences a battery over voltage (>15.5 VDC) on battery bank 1, the controller will stop operating, and the display will begin to flash with all icons. The controller will resume operating when the voltage drops to a normal level <15.5 VDC.

**Icons Displayed:** All symbols

#### NOTE

The controller does not display over voltage on battery 2.

### Low Voltage

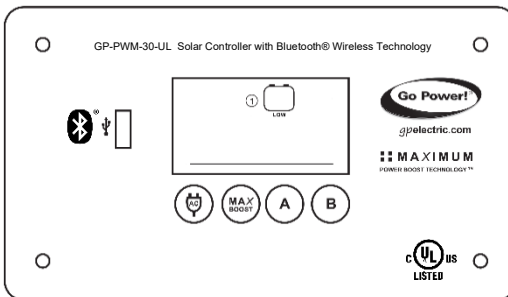

**Low battery 1:** If the SOC of battery bank 1 reaches 0%, the battery SOC symbol will show the text “LOW” beneath it. The controller will continue operating in this condition and will only stop operating if the voltage of Battery 1 drops below 9.0 VDC.

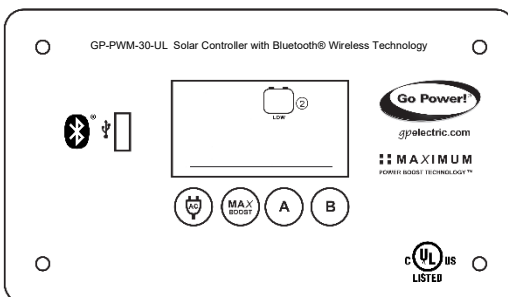

**Low battery 2:** If there are two battery banks connected and the SOC of battery bank 2 reaches 0%, the battery SOC symbol will show the text “LOW” beneath it. The controller will continue operating in this condition and will only stop operating if the voltage of Battery 1 drops below 9.0 VDC (this is because the GP-PWM-30-UL is powered by Battery 1).





**Icons Displayed:** Battery SOC Symbol, LOW, Symbol 1 or 2





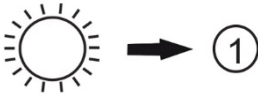

### Battery 1 Reverse Polarity

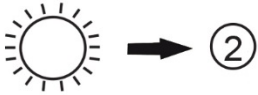



If the GP-PWM-30-UL senses reverse polarity on battery 1, the controller will stop operating, beep continuously and display POL. The controller will resume operating when the error is cleared.

**Icons Displayed:** POL

## 9.0 Display Symbols

Symbol	Indicator For:
<b>Battery 1</b>	
	Day Time: PV Charge Current
	Night Time
	Battery Voltage
	Battery State of Charge
<b>SEALED</b>	Sealed/Gel
<b>AGM</b>	AGM
<b>FLOODED</b>	Flooded
<b>LFP</b>	Lithium Iron Phosphate
<b>Battery 2</b>	
	Day Time: PV Charge Current

	<p>Night Time</p>
	<p>Battery Voltage</p>
	<p>Battery State of Charge</p>
<p><b>SEALED</b></p>	<p>Sealed/Gel</p>
<p><b>AGM</b></p>	<p>AGM</p>
<p><b>FLOODED</b></p>	<p>Flooded</p>
<p><b>LFP</b></p>	<p>Lithium Iron Phosphate</p>
<p><b>Other Symbols</b></p>	
	<p>USB charger on                  (When USB charger is off, no symbol will show)</p>
	<p>Inverter on                  (Can only be used when an inverter is hardwired. See Section 10. When inverter</p>
	<p>Flashing: Controller ready to pair                  Steady-on: Controller and mobile device connected via Bluetooth® communication</p>
<p><b>BOOST</b></p>	<p>Max Power Boost activated, Boost charge incomplete</p>
<p><b>LOW</b></p>	<p>Battery 1 / 2 voltage is lower than 11.0 VDC</p>
<p>Whole display will start to blink</p>	<p>Battery 1 voltage &gt; 15.5 VDC</p>
<p>No Symbol</p>	<p>Battery 2 voltage &gt;15.5 VDC</p>
<p><b>POL</b></p>	<p>Battery 1 reverse polarity</p>

Battery State of Charge	
Symbol	Battery Voltage
	≥ 12.8 VDC
	≥ 12.6 to 12.8 VDC
	≥ 11.8 to 12.6 VDC
	> 11.0 to 11.8 VDC
	≤ 11.0 VDC
100%	≥ 12.8 VDC
$SOC = \frac{\text{Battery Voltage} - 11.0V}{1.8V} (100\%)$	< 12.8 VDC and > 11.0 VDC
0%	≤ 11.0 VDC

## 10.0 Inverter Control (on/off)

The following Go Power!® inverters can be turned on/off through the GP-PWM-30-UL when a modular 6p4c RJ11 type connector is used (included with an optional Go Power!® inverter remote):

- GP-ISW700-12
- GP-ISW1000-12
- GP-ISW1500-TS
- 
- GP-ISW1500-12
- GP-ISW2000-12

**\*The GP-SW1500 Inverter is not compatible.**

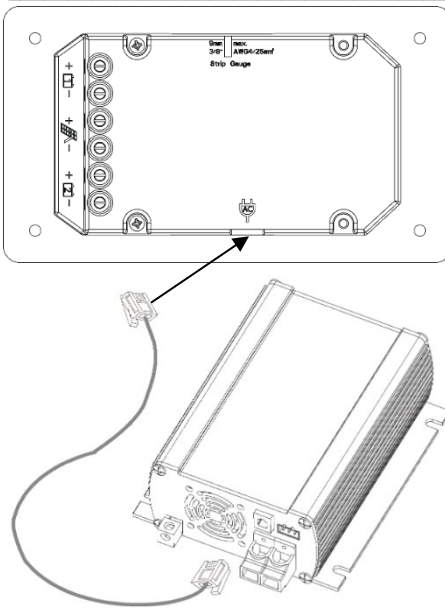

First, connect the inverter directly to the battery (follow the installation instructions included with the inverter). Then, connect the modular cable (found in the inverter remote box) to the remote terminal of the inverter and to the remote terminal of the GP-PWM-30-UL (marked with an **AC Plug symbol**).

Please change the switch of the inverter to Position 2 (Remote controlled).

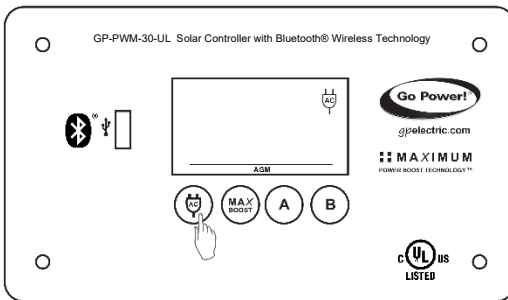

Now you can turn the connected inverter on or off by holding down the **AC Symbol Button** for 3 seconds.

The inverter is enabled when the **AC plug symbol** appears on the display and is off when it disappears.

An automatic inverter low voltage disconnect (LVD) will be implemented in the LFP

profile when the AC icon is active and the battery falls below 11.0V. The inverter will be reconnected once the battery has charged above 12.4V.

If the inverter is switched on by the AC button but LVD is recognized, then the AC symbol will flash. If the inverter is switched off by the AC button and/or by LVD, then the AC symbol will be off. If the inverter is switched on by the AC button and not switched off by LVD, then the AC symbol will be on.

## 11.0 USB Charging

The GP-PWM-30-UL offers a standard USB connector for delivering 5.0 VDC to small mobile appliances such as cell phones, tablets and small music players. This charging port can supply up to 800 mA of current.



Remove the rubber cover of the USB terminal to access the terminal.

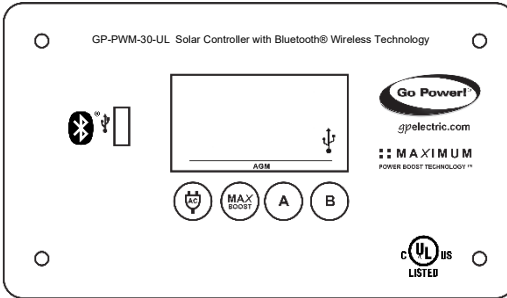

The USB charging port is active when the **USB symbol** appears on the display.

Battery 1, connected to the Battery 1 terminals, supplies the power for the USB charger. The controller disables the USB charger automatically if the battery bank 1 voltage drops below 11.0 VDC, and the USB icon will turn off.

If there is enough current from the PV array available to charge Battery Bank 1 above the reconnect voltage, the USB terminal will be enabled again. For Sealed/Gel, AGM, and Flooded profiles, the reconnect voltage is 12.8V. For the LFP profile, the reconnect voltage is 12.4V.

**WARNING:** Do not connect the charging device anywhere else! USB-Negative contact is connected to battery negative.

**AVERTISSEMENT :** Ne branchez pas l'appareil de charge ailleurs! Le contact USB-négatif est connecté au négatif de la batterie.

## 12.0 Bluetooth® Wireless Technology

The GP-PWM-30-UL comes with Bluetooth® Low Energy wireless technology for live status monitoring and settings configuration on mobile devices. It works together with the Go Power! Connect App, available for both Android and iOS devices.



Download and install the Go Power! Connect app, which is available on the Google Play store for Android devices and the App Store for iOS devices.

### 12.1 Pairing

When connecting for the first time, pairing between the charge controller and the mobile device is required. Also ensure your mobile device's Bluetooth® communication function is enabled. You will see the Bluetooth® symbol present on your status bar if so.

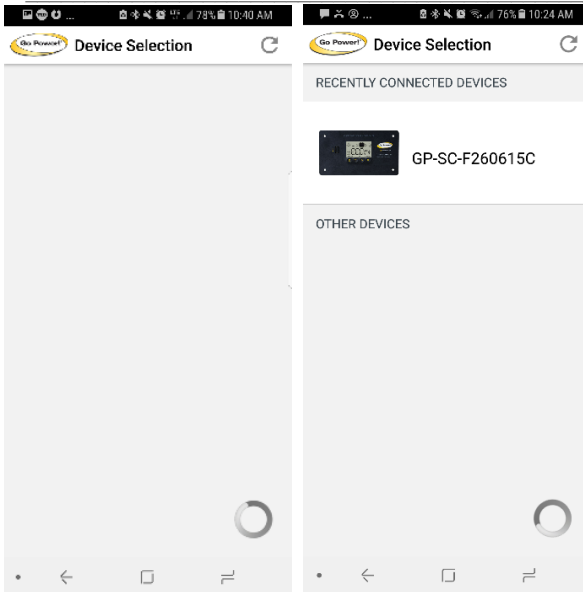

Open the app, and the Main page will prompt you to select devices.

To pair, press and hold the **A and B buttons** of the charge controller simultaneously for 3 seconds until the Bluetooth® symbol on the charge controller's display starts flashing.

Once this pairing process has been initiated on the charge controller, select the charge controller in the Device Selection main page of the Go Power! Connect app.

Device selection must be performed while the Bluetooth® symbol is still flashing on the charge controller's display. The flashing state will last for 60 seconds. If the charge controller is not selected on the Go Power! Connect app within this time, the pairing process is canceled, and the A and B buttons must be long pressed again.

Selecting the device will finalize the pairing process and a connection will be automatically established. The Bluetooth® symbol on the charge controller's display will become solid and the monitor page of the Go Power! Connect App will be started.

## 12.2 App Settings

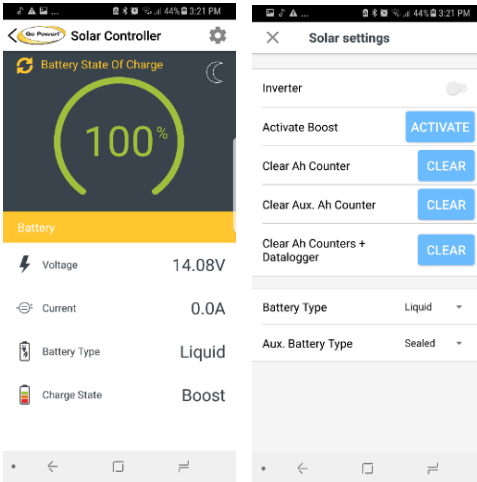

For a complete list of all functionality and instructions in the Go Power! Connect app, visit <https://gpelectric.com/support/>

## 12.3 General Info

Returning to the Main page for Selecting devices will disconnect the charge controller. The Bluetooth® symbol on the charge controller's display will turn off to indicate the disconnection. The devices will still remain paired for future use.

The pairing process is only required once for mobile phones connecting for the first time. Paired mobile phones can then connect at any time without pressing buttons on the charge controller.

The charge controller can simultaneously be paired with up to 8 mobile devices.

A soft reset of the charge controller will erase the list of paired devices in the charge controller. The reset can be performed by pressing the 4 buttons of the charge controller simultaneously for 3 seconds.

## 13.0 Frequently Asked Questions (FAQs)

Before a problem is suspected with the system, read this section. There are numerous events that may appear as problems but are in fact perfectly normal. Please visit <https://gpelectric.com/support/> for the most up-to-date FAQs and troubleshooting videos.

### **It seems like my flooded batteries are losing water over time.**

Flooded batteries may need to have distilled water added periodically to replace fluid loss during charging. Excessive water loss during a short period of time indicates the possibility of overcharging or aging batteries.

### **When charging, my flooded batteries are emitting gas.**

During charging, hydrogen gas is generated within the battery. The gas bubbles stir the battery acid allowing it to receive a fuller state of charge.

**Important:** Ensure batteries are in a well-ventilated space.

### **My voltmeter shows a different reading than the GP-PWM-30-UL display.**



The meter value on the GP-PWM-30-UL display is an approximate reading intended for indication purposes only. There is an approximate 0.1 VDC inherent error present that may be accentuated when compared with readings from another voltmeter.

There may be a slight difference between the battery voltage displayed on the GP-PWM-30-UL display and the battery voltage measured at the battery terminals. When troubleshooting using a voltmeter, check both the battery voltage at the GP-PWM-30-UL controller terminals and battery voltage at the battery terminals. If a difference of more than 0.5 VDC is noted, this indicates a large voltage drop possibly caused by loose connections, long wire runs, small wire gauge, faulty wiring, a faulty voltmeter or all the above. Consult the Suggested Minimum Wire Gauge chart in Section 6 for wiring suggestions and check all connections.

For advanced users:

The GP-PWM-30-UL makes voltage measurement adjustments based on resistance it detects at the battery terminals. In addition to resistance in the wires, batteries also have an internal resistance due to chemical properties. The controller cannot distinguish between these two sources of resistance. It will compensate up to 250mV in the displayed value.

## What causes a warning signal and when are the warnings triggered?

Connection	Warning	Notes	LCD
Battery 1 reverse polarity	"POL" on LCD and constant audible alarm		
Battery 2 reverse polarity	Battery 2 status display doesn't show	Battery 1 must be connected with correct polarity for unit to be powered on	
PV reverse polarity	"POL" on LCD and constant audible alarm		
PV short circuit		Unit shows moon symbol when PV is connected and in bright sunlight	 *must have bright sunlight on PV too

### Why does the voltage fluctuate so much when charging with the LFP setting?

Lithium batteries contain smaller battery cells. The voltages of these individual cells must be balanced during the charging process by the Battery Management System (BMS). Imbalances will cause fluctuations in the battery voltage measurement, but this will stabilize as the cells are charged and balanced.

Additionally, lithium batteries have higher resistance than lead acid batteries. This affects the charge controller's battery voltage measurements and its compensation for wire resistance.

Reduce wire inductance which may also cause voltage fluctuations. Keep battery wires close together, or gently twist positive and negative wires together.

### I don't see my charge controller in the Device Selection screen of the Go Power! Connect app.

The Device Selection screen will only display a charge controller that has already paired with the mobile device or a charge controller that is in the pairing process. The pairing process is initiated by pressing simultaneously the A and B buttons for 3 seconds. This is needed only when the mobile device is connecting with the charge controller for the first time.

---

**I cannot connect to the Go Power! Connect app.**

The mobile device with the Go Power! Connect app has to be close enough to the charge controller. Distances of up to 20 meters in open space should work.

## 14.0 Troubleshooting Problems

### How to Read this Section

*Troubleshooting Problems* is split into three sub-sections, grouped by symptoms involving key components. A multimeter or voltmeter may be required for some procedures listed.

It is imperative all electrical precautions stated in the Warning Section and outlined in the Installation Section are followed. Even if it appears the system is not functioning, it should be treated as a fully functioning system generating live power.

### 14.1 Problems with the Display

**Display Reading:** Blank

**Time of Day:** Daytime/Nighttime

**Possible Causes:**

Battery or fuse connection and/or solar array connection (Daytime only) or battery or fuse connection (Nighttime only).

**How to tell:**

Check the voltage at the controller battery terminals with a voltmeter and compare with a voltage reading at the battery terminals.

If there is no voltage reading at the controller battery terminals, the problem could be a fuse, or the wiring between the battery and the controller. If the battery voltage is lower than 6 volts the controller will not function.

For the solar array, repeat steps 1 and 2 substituting all battery terminals with solar array terminals.

**Remedy:**

Check all connections from the controller to the battery including checking for correct wire polarity. Check that all connections are clean, tight, and secure. Ensure the battery voltage is above 6 volts.

**Display Reading:** Nighttime

**Time of Day:** Daytime

**Possible Causes:**

Panel is covered by something; PV panel is too dirty to supply a high enough voltage to charge the battery; PV panel is not connected.

**Remedy:**

Check the panel and to ensure it is not obscured. Clean the panel if it is dirty.  
Check that PV cables are connected to the controller.

## 14.2 *Problems with Voltage*

**Voltage Reading:** Inaccurate

**Time of Day:** Daytime/Nighttime

**Possible Cause:**

Excessive voltage drop from batteries to controller due to loose connections, small wire gauge or both.

**How to tell:**

Check the voltage at the controller battery terminals with a voltmeter and compare with the voltage reading at the battery terminals.

If there is a voltage discrepancy of more than 0.5 VDC, there is an excessive voltage drop.

**Remedy:**

Check all connections from the controller to the battery including checking for correct wire polarity. Check that all connections are clean, tight, and secure. Shorten the distance from the controller to battery or obtain larger gauge wire. It is also possible to double up the existing gauge wire (i.e. two wire runs) to simulate a larger gauge wire.

## 14.3 *Problems with Current*

**Current Reading:** 0 A

**Time of Day:** Daytime, clear sunny skies

**Possible Cause:**

Current is being limited below 1 Amp as per normal operation or poor connection between solar array and controller.

**How to tell:**

The State of Charge (SOC) screen is close to 100% and the Sun and Battery icon are present with an arrow between.

With the solar array in sunlight, check the voltage at the controller solar array terminals with a voltmeter.

If there is no reading at the controller solar array terminals, the problem is somewhere in the wiring from the solar array to the controller.

**Remedy:**

Hold down the MAX BOOST Button for approximately 3 seconds to activate Maximum Power Boost. This will allow the controller to charge batteries to 14.4 +/- 0.1 VDC (14.1 +/- 0.1 VDC Sealed/Gel) with all current the solar array is producing.

Check all connections from the controller to the array including checking for correct wire polarity. Check that all connections are clean, tight, and secure. Continue with the solutions below for additional help on low current readings.

**Current Reading:** Less than expected

**Time of Day:** Daytime, clear sunny skies

**Possible Causes:**

1. Current is being limited below 1 Amp as per normal operation.
2. Incorrect series/parallel configuration and/or wiring connections and/or wire gauge.
3. Dirty or shaded module or lack of sun.
4. Blown diode in solar module when two or more modules are connected in parallel.
5. The battery is full.

**How to tell:**

1. Battery State of Charge screen is close to 100% and the Sun and Battery icon are present with an arrow in between.
2. Check that the modules and batteries are configured correctly. Check all wiring connections.
3. Modules look dirty, overhead object is shading modules or it is an overcast day in which a shadow cannot be cast.

**NOTE**

Avoid any shading no matter how small. An object as small as a broomstick held across the solar module may cause the power output to be significantly reduced. Overcast days may also cut the power output of the module.

4. Disconnect one or both array wires from the controller. Take a voltage reading between the positive and negative array wire. A single 12 volt module should have an open circuit voltage between 17 and 23 VDC. If you have more than one solar module, you will need to conduct this test between the positive and negative terminals of each module junction box with either the positive or the negative wires disconnected from the terminal.

**Remedy:**



- 
2. Reconnect in correct configuration. Tighten all connections. Check wire gauge and length of wire run. Refer to Suggested Minimum Wire Gauge in Section 6.
  3. Clean modules, clear obstruction or wait for conditions to clear.
  4. If the open circuit voltage of a non-connected 12 volt module is lower than the manufacturer's specifications, the module may be faulty. Check for blown diodes in the solar module junction box, which may be shorting the power output of module.

---

## 15.0 Limited Warranty

Go Power! warrants the GP-PWM-30-UL for a period of five (5) years from the date of shipment from its factory. This warranty is valid against defects in materials and workmanship for the five (5) year warranty period. It is not valid against defects resulting from, but not limited to:

- Misuse and/or abuse, neglect or accident
- Exceeding the unit's design limits
- Improper installation, including, but not limited to, improper environmental protection and improper hook-up
- Acts of God, including lightning, floods, earthquakes, fire, and high winds
- Damage in handling, including damage encountered during shipment

This warranty shall be considered void if the warranted product is in any way opened or altered. The warranty will be void if any eyelet, rivets, or other fasteners used to seal the unit are removed or altered, or if the unit's serial number is in any way removed, altered, replaced, defaced, or rendered illegible.

### 15.1 *Repair and Return Information*

Visit <https://gpelectric.com/support/> to read the "frequently asked questions" section of our website to troubleshoot the problem. If trouble persists:

1. Fill out our online Contact Us form or Live Chat with us
2. Email [techsupport@gpelectric.com](mailto:techsupport@gpelectric.com)
3. Return defective product to place of purchase

## 16.0 Installation Template

Use the template on page 35 for flush mounting the controller.

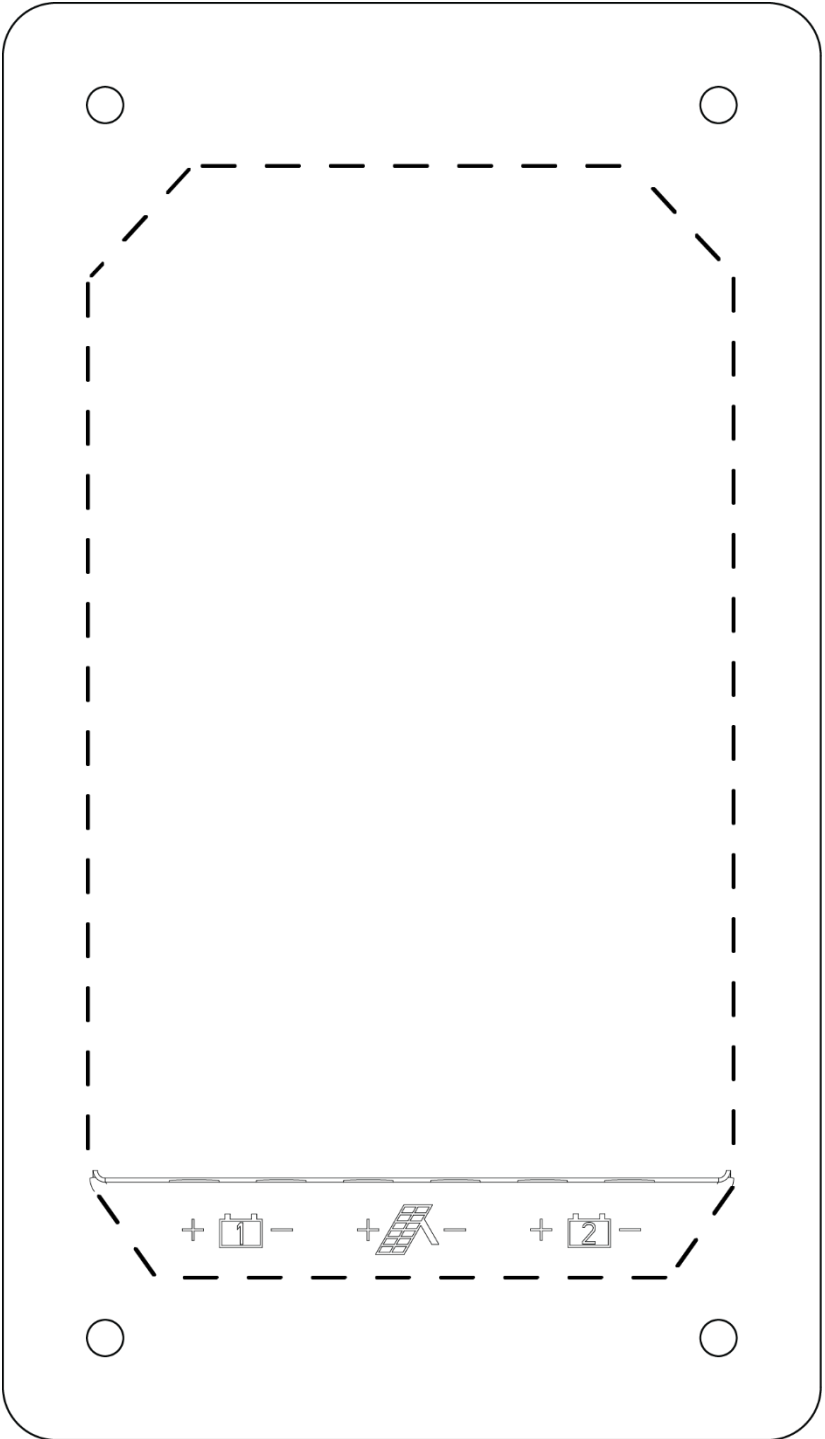



© 2019 GO POWER!®

201 – 710 Redbrick St,  
Victoria, British Columbia  
Canada, V8T 5J3

MOBI\_MAN\_GP-PWM-30-UL\_RevA

**gp**electric.com